



Quality Replacement Parts, Inc.
"For The Clay Target Industry"

9099 Bank Street, Suite B • Valley View, OH 44125

Price List & Parts List

Prices subject to change without notice

Phone 800-742-0425 • 216-674-0200 • Fax 216-674-0202

automatic trap. . . automatic trap. . . automatic trap

<u>Part No.</u>	<u>Description</u>	<u>Price</u>
QRP-22-AT	Windage Adj. Base Pivot Assy	49.66
QRP-23-AT	Windage Latch Plunger	8.29
QRP-23-ATa	Windage Latch Locating Bushing	3.89
QRP-23-ATb	Windage Latch Guide Bushing	4.94
QRP-23-ATc	Windage Latch Post	6.62
QRP-32-AT	Carrier Arm Rail, Automatic 11 1/2"	11.65
QRP-32-IAT	Carrier Arm Rail, Automatic, Int'l 12 1/2".	14.91
QRP-47-AT	Escapement Roll Cam	11.13
QRP-51-AT	Escapement Lever Spring	1.68
QRP-85-AT	Roll Pins for Index Shaft (6 ea.)	1.68
QRP-91-AT	Roll Pin53
QRP-130-AT	Angle Changing Motor Coupling	16.80
QRP-130-ATa	QRP-130-AT Hub Only (2 required)ea	7.25
QRP-130-ATb	QRP-130-AT Spider Only	2.52
QRP-131-AT	Angle Changing Motor	170.10
QRP-131-ATa	Bud Box (for Angle Changing Motor)	6.00
QRP-135-AT	Elevation Pivot Assembly	12.18
QRP-136-AT	Elevation Screw Swivel	12.18
QRP-137-AT	Elevation Adjusting Bar	12.18
QRP-137-AT-A	Elevation Adjusting Screw Ass'y	66.67
QRP-137-AT-S	Elevation Adjusting Collar	7.25
QRP-140-AT	Elevation Adjusting Bushing	14.39
QRP-143-AT	Target Stop Finger	7.25
QRP-144-AT	Stop Finger Retainer Collar	1.37
QRP-145-AT	Stop Finger Guide Pins (4 ea)42
QRP-146-AT	Stop Finger Spring95
QRP-149-AT	Target Feed Finger	2.21
QRP-177-AT	Escapement Plunger (adjustable)	15.44
QRP-179-AT	Escapement Push Rod Holder Ass'y	8.19
QRP-181-AT	Magazine Extension Set/Auto	327.60
QRP-182-AT O	Magazine OUTER Rail, 20 required	11.87
QRP-182-AT I	Magazine INNER Rail, 10 required	9.66
QRP-204-AT S	Target Fd Shf Ass'y (for 1577)	20.68
QRP-204-AT L	Target Fd Shf Ass'y (for 1582 & 1583)	30.34
QRP-215-AT	Roller Stud	8.29
QRP-219-AT	Woodruff Key (for Mainshaft Sprocket)	1.05
QRP-220-AT	Index Chain Assembly	16.07
QRP-221-AT	Index Chain Link ONLY	1.68
QRP-231-AT	Angle Changing Shaft Only	19.32
QRP-238-AT	Idle Gear Shaft	20.48
QRP-240-AT	Angle Change Control Hub <u>Only</u>	49.66
QRP-240-ATb	We Assemble into Your Gear (Labor)	5.57
QRP-248-AT	Angle Change Disc	49.66

5

<u>Part No.</u>	<u>Description</u>	<u>Price</u>
QRP-249-AT	Target Spread Adjustment Screw	9.35
QRP-250-AT	Angle Changing Link Assembly	112.35
QRP-251-AT	Angle Changing Link Pin	7.25
QRP-253-AT	Angle Change Link Support Washer	1.68
QRP-254-AT	Angle Changing Link Hub	49.66
QRP-257-AT	Angle Change Switch	13.76
QRP-267-AT	Disc Shaft	7.77
QRP-270-AT	Angle Change Link Spring	4.30
QRP-278-AT	Timing Motor (for 1577)	92.72
QRP-279-AT	Interrupter Switch	13.86
QRP-325-AT	Load Leveler Support Assembly	24.89
QRP-331-AT	Release Relay	36.44
QRP-336-AT	Angle Switch	14.07
QRP-363-AT	Magazine Escapement Cushion	4.41
QRP-364-AT L	Target Stop Plunger	10.50
QRP-364-AT S	Target Stop Plunger	10.50
QRP-365-AT L	Target Plunger Holder	13.10
QRP-365-AT S	Target Plunger Holder	13.10
QRP-366-AT	Target Stop Plunger Spring	1.99
QRP-428-AT	Target Buffer (eliminates pad)	4.73

<u>Part No.</u>	<u>Description</u>	<u>Price</u>
QRP-23-IT	Elevation Adjustment Screw (right)	19.32
QRP-24-IT	Elevation Adjustment Screw (left)	15.44
QRP-32-IAT	Carrier Rail (Int'l)	14.91
QRP-40-TS I	Main Spring, Int'l Strength	38.64
QRP-40-TS I A	Main Spring, Int'l Assembly	67.30
QRP-237-IT	Elevation Changing Motor (Conversion parts may be necessary)	192.15

automatic trap . . .

int'l trap parts . . .

snubber parts . . .

<u>Part No.</u>	<u>Description</u>	<u>Price</u>
QRP-135-T	Complete Snubber Assembly	176.40
SN-135-RB	Snubber Rebuild Kit	3.50
SN-135	Snubber Housing <i>Only</i>	60.00
SN-136	Snubber Cylinder	18.60
SN-137	Cylinder Cap	8.60
SN-138	Cylinder Gland	16.70
SN-139	Back Up Washer	1.00
SN-140	Retaining Washer	1.50
SN-141	Piston	12.90
SN-142	Piston Rod	11.20
SN-143	Clevis	8.80
QRP-144-T	Snubber Clevis Pin	5.78
QRP-145-T	Snubber Trunion Pin	6.93
QRP-146-T	Snubber Trunion Screw (2 ea.)84
SN-147	Retaining Ring80
SN-154	Snubber Filler Plug80
SN-168	Valve Disc	1.60

6

<u>QRP No.</u>	<u>Part No.</u>	<u>Assembles into:</u>	<u>Price</u>
BU-28 #	V103A	V47W70
BU-29	X243	Spacer (3 required) (Eliminates factory interrupter gears)	1.90
BU-30	X132	Thrust Bearing - Worm Shaft	9.80
BU-31 #	X106A	X36W-Oil Seal	4.20
BU-32 #	V105	V3AW - Oil Seal	4.20
BU-33	X196A	X16BW - X3AW - X4BW90
BU-34	X226A	X3A- XS3A	1.60
BU-35	U92	U185	1.60
BU-36	U237	U236W1.75	1.80
BU-37	U102	U1W - U214AW	1.70
BU-38	U378	U2AW	4.90
BU-3		Thrust Washer-QRP-108-T/X108AW	2.70
BU-40	U101	U180AW	2.00
BU-41	V60A	V57A	2.50
BU-42		QRP-4-T & X4	1.30
BU-43		QRP-4-T & X4	1.30
BU-44		QRP-4-T & X4	1.30
BU-45	R018A	U393W	1.60
BU-46	U394	U303W/U398W	1.70
RB-X3A-T		Pivot Bushing (ream hole to .625)	3.50

bushings . . . bushings

bushings . . . bushings

<u>Winchester</u>		<u>Price</u>
<u>QRP No.</u>	<u>Part No.</u>	<u>Assembles into:</u>

BU-1X95		V3AW-X1BW-X36W	1.70
BU-11 *	X101	X3AW-XS3AW	1.70
BU-12 *	X97A	X27W	1.60
BU-13 *	X98A	U312W -U401W XU40W -X29W	1.60
BU-14* #	X100	V23W-XIBW-X108AW	1.70
BU-15 *	X102A	X3AW -XS3AW -X114W -X4BW	1.90
BU-16 *	X103A	X108AW - OD Step Bushing	6.30
BU-17 *	X104	X3AW - XS3AW (SET)	10.30
	X105	Separately, each piece	6.20
BU-18 *	X96	X135W	1.60
BU-19	X161	X35	2.10
BU-20 #	V99A	V110W	1.60
BU-21 #	V96A	V3AW	2.50
BU-22 #	V97	V108AW	2.00
BU-23	V100	U190W - U4W - V4W - V194W	1.60
BU-23L #	X227	U190W (<i>longer</i>)	1.50
BU-24 * #	V104B	V192W - X3AW - XS3AW	1.50
BU-25 #	V102	U398W -V50AW	1.60
BU-26	X99	X110W	1.70
BU-27 * #	V101	V155AW - X3AW - XS3AW	1.60

<u>Part No.</u>	<u>Description</u>	<u>Price</u>
BU- 100	"X" Machine Bushing Set (Includes enough of each bushing marked with (*) to rebush one "X" machine. Does not include bearing or seal.)	\$49.90
BU-102	Skeet Machine Bushing Set (Includes enough of each bushing marked with (#) to rebush one Skeet machine. Includes oil seals, plus V98A bushing.)	\$42.00
BU-104	Automatic Bushing Set (V1582/V1583) Includes all bushings for these machines	\$95.30
BU-106	Automatic Bushing Set (V1577) Includes all bushings for this machine	\$88.20

bushing sets . . .

<u>Rebuilding Services</u>	<u>Price</u>
Rebuild <i>Western</i> Skeet Machine	\$ 500.00
Estimated plus parts and shipping	
<ul style="list-style-type: none"> • Itemized parts list provided • Additional charge for welding • Old parts returned upon request 	
Rebuild <i>Western</i> "X" Trap Machine	500.00
Estimated plus parts and shipping	
<ul style="list-style-type: none"> • Itemized parts list provided • Additional charge for welding • Old parts returned upon request 	
Turn and thread old style spring ends and furnish a new adjustment end	26.50
RB-135 Rebuild a Snubber; includes a rebuild kit, oil and labor All other parts extra.	38.00
Rebuild a QRP-33-TA/X33W All parts extra	35.00
Rebuild X68DW All parts extra	35.00
Rebuild QRP-108-TA/X108AW All parts extra	35.00
Rebuild <i>Western</i> or REMINGTON Automatic Average cost	\$1,800.00 -\$2,400.00
Includes parts and labor, shipping extra	
Rebuild V9AW (includes new QRP-113-S pins installed)	96.00

<u>Part No.</u>	<u>Description</u>	<u>Price</u>
13060	Target stop wing nut	1.00
13249	Mag finger spring drive screw	1.00
13300	Magazine finger spring	1.89
13440	Power connector box	17.00
13341	Release connector box cover	9.80
13466	Power cable plug	42.10
13535	Micro switch	13.00
13570	Base	78.00
13571	Carrier assembly	118.50
13572	Carrier	66.20
13573	Target guide rubber	3.50
13574	Carrier arm	63.80
13575	Carrier bolt	1.00
13576	Clutch housing	98.00
13577	Clutch housing spring	8.20
13578	Clutch housing thrush washer	7.80
13579	Crank pin	10.90
13580	Crank pin retaining ring	1.00
13581	Eyebolt bushing	12.15
13582	Frame assembly	158.00
13583	Frame	162.00
13584	Mainshaft bearing - lower	5.46
13585	Mainshaft bearing - upper	7.25
13586	Name plate	5.65
13588	Sear pivot bolt	1.00
13589	Frame wing nut	3.50
13590	Mainshaft	86.20
13591	Mainshaft crank	86.30
13592	Mainshaft crank extension	35.00
13593	Mainshaft crank extension screw	1.00
13597	Mainspring adjusting nut	1.00
13598	Mainspring adjusting washer	2.84
13599	Rear frame closure	56.70
13600	Rear frame closure screw	1.00
13601	Sear assembly	79.17
13602	Sear	58.15
13603	Mounting bolt	2.10
13604	Mounting bolt washer	1.00
13605	Sear pivot spacer	7.30
13607	Sear spring	4.57
13612	Trigger assembly	77.80
13613	Trigger	58.90
13614	Sear Bushing	10.87

<u>Part No.</u>	<u>Description</u>	<u>Price</u>
13615	Target stop adjusting screw	1.00
13617	Trigger rod	39.70
13618	Crank pin thrust washer	5.46
13619	Clutch housing cover washer	7.40
13620	Perimeter ring assembly	135.80
13622	Perimeter ring bolt	1.00
13623	Perimeter ring wing nut	1.00
13624	Front ring support	69.10
13625	Front ring support brace	5.35
13626	Perimeter ring - front	30.00
13627	Perimeter ring - rear	25.90
13629	Rear ring support	7.80
13630	Frame mounting bolt	2.20
13631	Frame nut	1.00
13632	Mounting bracket - top	11.34
13633	Mounting bracket - bottom	11.87
13634	Mounting bracket screw	1.00
15028	Target stop	1.00
32540	Remote control assembly	73.00
32960	Magazine support leg R.H.	92.10
32961	Magazine support leg L.H.	92.00
33325	Mainspring assembly	110.25
33330	Mainshaft crank assembly	75.59
33335	Mainshaft assembly-trap	235.00
33336	Mainshaft assembly-skeet	235.00
33415	Target drop pad assembly	22.26
33480	Main spring assembly BR-78	66.26
3368	Skeet service manual 4100	13.90
33910	Mainshaft crank assembly	77.30
34113	Throwing arm assembly	240.30
3430	BR-78 trap service manual	13.90
3455	Trap service manual 4100	13.90
90583	Mainspring swivel washer	11.97
90584	Mainspring	66.26
90585	Throw arm pivot pin	1.00
90586	Curly adjusting nut	10.40
90587	Oiling cover	5.90
90588	Clutch key	4.59
90590	Elev. adj. screw right hand assembly	20.90
90591	Elev. adj. screw left hand assembly	22.16
90592	Throwing arm pivot	8.19
90593	Lock nut68
90594	Control panel hookup wire (red)	1.05

<u>Part No.</u>	<u>Description</u>	<u>Price</u>
90595	Control panel fuse receptacle	6.09
90596	Control panel fuse	1.99
90597	Safety release toggle switch	37.43
90598	Control panel terminal block	7.98
90599	Control panel marker strip	2.05
90600	Control panel terminal jumper	1.00
90601	Washer (6 each)	1.00
90602	Screw	1.00
90604	Actuating link nut	1.00
90605	Control panel terminal	1.00
90606	Terminal block mount screw	1.00
90607	Release cable receptacle	61.84
90608	Power Cord Receptacle	42.50
90609	Pivot shaft cam switch	34.44
90610	Timing motor	83.00
90611	Timing motor brack term blk	4.73
90612	Switch mounting screw	1.00
90613	Timing motor mount screw	1.00
90618	Cable	2.80
90619	Cable	1.50
90620	Terminal	1.00
90621	Cable	2.00
90622	Terminal	1.00
90624	Mainshaft universal joint	113.30
90625	Mainshaft sprag clutch	160.65
90626	Speed reducer sprocket	25.52
90627	Drive chain	21.53
90628	Universal housing pivot bearing	4.73
90629	Angling link pivot bearing	5.04
90630	Pivot shaft bearing	6.20
90631	Pivot bearing	10.92
90632	Lower mag shaft bearing	10.29
90633	Pivot bearing	5.25
90634	Damper rod extension bearing	2.94
90635	Universal shaft bearing	8.40
90636	Pivot shaft bearing bottom	6.41
90637	Angling yoke bearing	3.78
90638	Mainspring bearing	3.57
90639	Angling shaft/lower	7.77
90640	Thrust bearing	8.09
90641	Angling shaft thrust bearing	5.35
90642	Angling yoke thrust bearing	4.09
90643	Mainshaft thrust bearing	4.20

remington remington remington remington remington

<u>Part No.</u>	<u>Description</u>	<u>Price</u>
90644	Pivot shaft thrust bearing	9.45
90645	Damper pivot pin	19.55
90646	Angling link pivot pin	67.09
90647	Retaining ring	1.00
90648	Retaining ring	1.00
90649	Ring	1.00
90651	Key	1.58
90652	Power Cord	97.13
90653	Release cord assembly	157.50
90654	Elev. adj. knob spring	6.51
90655	Pivot screw	11.55
90656	Ang. yoke cover lock screw	1.00
90657	Screw	1.00
90658	Windage adj clamp screw	1.00
90659	Mainspring pin	1.00
90660	Screw	1.00
90661	Cocking clutch key screw	1.00
90662	Screw (4 each)	1.00
90663	Washer (4 each)	1.00
90664	Key	1.00
90665	Mainshaft gear stud screw	1.42
90666	Damper rod ext lock nut	1.00
90667	Control panel cover screw	1.00
90669	Chain tension bolt	1.50
90670	Washer	1.00
90671	Screw	1.00
90672	Windage adj knob lock screw	1.00
90673	Wing nut	1.00
90674	Target stop screw	1.00
90675	Throwing arm carrier washer	1.00
90676	Throwing arm screw	1.00
90677	Cone compression spring	9.19
90678	Throw arm carrier clamp screw	1.00
90679	Screw	1.00
90680	Ang. shaft clutch housing screw	1.00
90681	Mainshaft clutch housing screw	2.52
90682	Washer	1.00
90683	Nut	1.00
90684	Clutch housing screw	1.00
90685	Washer	1.05
90686	Bolt	1.58
90687	Nut	1.00
90688	Elev. knob lock washer	1.00

9

<u>Part No.</u>	<u>Description</u>	<u>Price</u>
90689	Screw	1.00
90690	Washer	1.00
90691	Angling clutch gear screw	1.00
90693	Washer	1.00
90694	Ang. crank lock screw	1.00
90695	Screw	1.00
90696	Bearing	2.42
90697	Clutch actuating lever pin	1.05
90698	Clutch actuating lever screw	3.15
90699	Damper fill plug	1.31
90700	Washer	1.00
90701	Drive motor	218.40
90702	Lock nut	1.00
90703	Nut	1.00
90704	Screw	1.00
90705	Elev. screw spring mounting pin	1.00
90706	Terminal block mtg. screw	1.00
90707	Switch connector	2.73
90708	Pivot shaft cam swth spacer pt	1.26
90709	Pivot shaft terminal block	2.73
90710	Cable clip	2.42
90712	Bearing	6.41
90713	Control panel mounting screw	1.00
90714	Cover panel screw	1.00
90716	Timing cam set screw	1.00
90717	Jam nut	1.00
90718	Mag cam spacer	3.50
90722	Mag ramp spacer	5.60
90723	Mag drive gear shaft	4.50
90724	Magazine key	1.00
90725	Mag drive gear bearing	4.10
90726	Input shaft bearing	5.80
90727	Index clutch shaft bearing	3.85
90730	Mag input shaft gear	32.97
90732	Mag drive chain	19.11
90735	Brush-mounting plate	4.20
90736	Mag cam roller	3.20
90737	Screw	3.10
90738	Bushing bearing	1.30
90742	Finger spring lock nut	1.00
90743	Screw	1.00
90744	Bushing set screw (4 each)	1.00
90746	Finger spring screw	1.00

remington remington remington remington

90747	Screw	1.00
90748	Mag cam screw	1.00
90749	Mag cam nut	1.00
90750	Screw	1.00
90751	Mag ramp screw	1.00
90752	Screw	1.00
90754	Nut	1.00
90756	Mag shaft gear key	1.75
90757	Clutch clamp screw	1.00
90758	Angling crank shaft	95.20
90760	Mainshaft drive arm	48.83
90761	Pivot shaft	37.73
90762	Mainshaft	58.06
90763	Clutch actuating lever	39.16
90764	Actuating lever bracket	63.00
90765	Angling clutch gear	113.70
90766	Mainshaft gear	127.89
90767	Cocking clutch sprocket	75.70
90768	Curl adjusting screw	18.38
90770	Angling link	25.70
90771	Thrust washer	16.96
90773	Angling pivot pin	32.34
90774	Angling crank	87.15
90775	Windage adjusting screw	17.30
90777	Mainspring front plug	21.42
90778	Damper rod extension	48.93
90780	Pivot shaft switch bracket	33.49
90781	Pivot shaft cam	5.35
90782	Timing motor bracket	35.60
90783	Angling yoke cover	19.32
90784	Windage adjustment knob	15.23
90785	Target guide rail	18.27
90787	Elevation adjustment knob	36.65
90788	Universal housing shaft	31.61
90789	Bellows mounting plate - front	7.56
90790	Bellows mounting plate - rear	8.29
90791	Bellows mounting plate bracket	24.89
90792	Damper pivot	34.55
90793	Mainshaft clutch housing	90.72
90794	Mainshaft clutch back plate	5.67
90795	Angling shaft clutch housing	111.51
90796	Speed reducer bracket - front	19.10
90797	Speed reducer bracket - rear	14.60

<u>Part No.</u>	<u>Description</u>	<u>Price</u>
90798	Target Stop	24.89
90799	Windage adjusting screw clamp	22.26
90800	Control instruction plate	5.80
90802	Buffer ring	7.30
90803	Angling clutch	465.73
90804	Cocking clutch solenoid	60.69
90805	Control panel guard	6.50
90806	Thrust washer	1.00
90808	Cover front	6.51
90809	Wiper retaining plate	5.46
90810	Wiper	1.58
90811	Cocking clutch gear	104.69
90812	Rel. solenoid cont. cable assembly	3.89
90813	Timing motor assembly	135.25
90814	Pivot shaft cam switch assembly	74.34
90815	Windage adjusting screw assembly	93.45
90816	Slide block assembly	51.34
90817	Mainspring adjusting screw assembly	35.59
90818	Clutch act. lever assembly	162.96
90820	Motor control cable assembly	15.49
90821	Cam switch control cable assembly	15.49
90822	Ang. solenoid control cable assembly	15.49
90827	Seal retaining plate	5.46
90828	Seal	15.80
90829	Magazine connecting shaft	44.52
90830	Mag ramp spacer	6.51
90831	Floor plate boss	27.20
90832	Magazine shaft gear	119.54
90834	Magazine drive sprocket	45.30
90835	Magazine drive gear	72.55
90836	Magazine input shaft	17.01
90837	Magazine shaft	45.46
90839	Target nest bracket	16.48
90840	Magazine ramp spacer	12.08
90841	Target nest brush	9.55
90842	Magazine sleeve	3.41
90843	Target bumper	2.57
90844	Stack height disc	15.12
90845	Stack height rod	16.59
90846	Magazine power cable assembly	21.00
90847	Power recept. assembly	26.36
90849	Mag. Index clutch assembly	347.29
90852	Control panel	33.60

<u>Part No.</u>	<u>Description</u>	<u>Price</u>
90853	Throwing arm carrier	186.06
90854	Throwing arm	40.37
90855	Angling yoke	125.48
90856	Hydraulic damper	132.41
90857	Bellows	98.80
90858	Nameplate	14.91
90859	Cocking clutch assembly	411.08
90860	Cocking clutch spring	131.75
90861	Control panel assembly	170.63
90862	Magazine cam	32.55
90863	Target nest arm	30.56
90864	Magazine finger	38.43
90865	Actuating lever link	9.13
90867	Magazine	367.65
90868	Magazine ramp	130.41
90869	Platform	174.83
90871	Magazine floor plate	145.32
90872	Magazine gear box	250.40
90873	Mainshaft housing	720.00
90874	Universal housing	190.00
90875	Base	1,183.30
90877	Cover	124.32
90878	Power cable connector	1.00
90879	Auto angle switch	14.81
90880	Cocking clutch gear screw	1.00
90945	Clutch act lever spring	5.88
90959	Angling link spacer	5.35
90968	Toggle switch boot	5.99
90991	Clutch solenoid buffer	2.31
90999	Counter	40.21
91011	Base	1,233.40
91030	Angling clutch set screw	1.00
91031	Input shaft set screw	1.00
91032	Mag drive shaft coupling end	12.50
91033	Mag drive shaft set screw	1.00
91034	Mag drive shaft coupling spacer	9.19
91035	Coil	48.83
91037	Damper pivot pin retaining ring	1.00
91038	Drive chain link	1.58
91039	Cam switch wire assembly	1.99
91040	Timing cam assembly	12.39
91061	Remote control box	5.35
91062	Remote control cover	1.16
91064	Switch	21.84

<u>Part No.</u>	<u>Description</u>	<u>Price</u>
91065	Cont. instruction plate	6.30
91107	Platform reinforcement	24.04
91126	Target stop roll pin	1.00
91201	Target guide	9.45
91209	Mainshaft universal joint set screw	1.00
91319	Auto angle switch assembly	15.23
91320	Safe relay switch assembly	32.70
91325	Mainspring rear plug assembly	46.52
91328	Ang. pivot pin assembly	36.54
91331	Throwing arm carrier shim	1.00
91343	Cocking clutch shaft	43.37
91344	Control panel assembly	60.00
91345	Control panel	16.00
91346	Control panel marker strip	4.20
91347	Control panel terminal block	4.90
91351	Cover panel	66.57
91352	Cover plate	12.50
91353	Mainshaft	93.24
91354	Mainshaft clutch housing screw	1.50
91355	Mainspring pivot	69.51
91356	Mainspring pivot block screw	2.31
91357	Mainspring pivot block washer	1.00
91358	Nameplate	9.40
91359	Power cable assembly	43.40
91363	Cover	124.32
91364	Micro switch	23.63
91382	Cable	2.50
91441	Concentricity ring	25.20
91444	Mainshaft clutch housing assembly	call
91445	Cocking clutch shaft bearing	10.82
91447	Power connector box assembly	63.70
91448	Skeet release cord assembly	165.00
91449	Release cord receptacle	79.59
91460	Safety release pendant assembly	86.60
91463	Spring	46.73
91464	Angling clutch spring	24.47
91465	Drive spring	23.42
91497	Target positioner	4.99
91512	Sprag clutch oil hole cover	3.80
91589	Speed reducer	354.27
91590	Speed reducer bracket	45.68
91591	Decal	1.00
91826	Cord assembly	18.27
91900	Bushing set, 4100T	199.50

Ship your QRP-110-T or X110 with broken bronze gear and we will assemble a new gear into it for the cost of the bronze gear only.

QRP-153-T Interrupter gear (bronze) ----- 

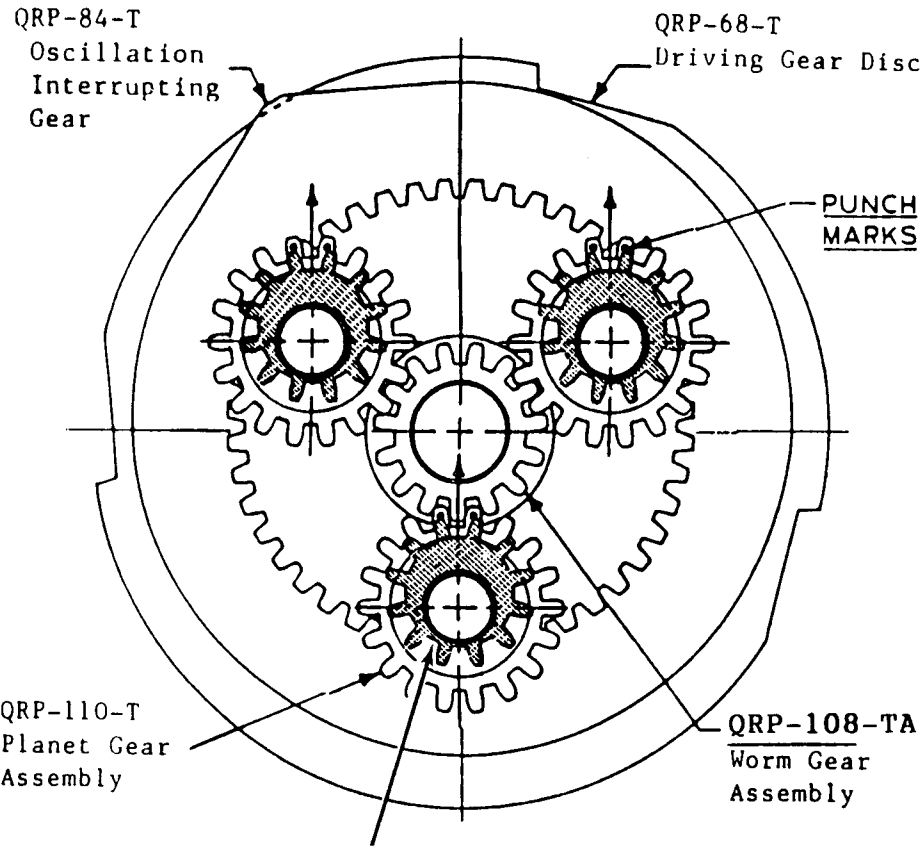

QRP-153-T Interrupter Gear (bronze)

IMPORTANT: Damage will result if QRP-110-T gears are not installed correctly. The QRP-184-T gear is driven by the bronze gears located on the underside of the three QRP-110-T gears. Assemble components so that punch marks on teeth of the QRP-110-T gears are oriented in the same parallel direction when gears are in mesh (see diagram). After assembly, check to ensure that gears rotate freely without binding. Rotate gears by hand at least seven times.

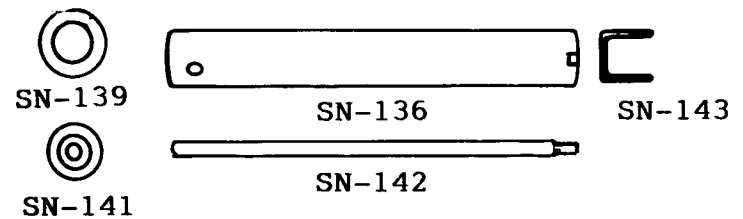
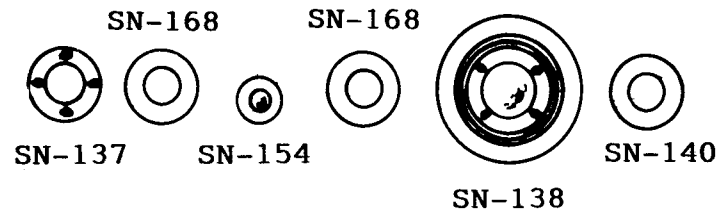
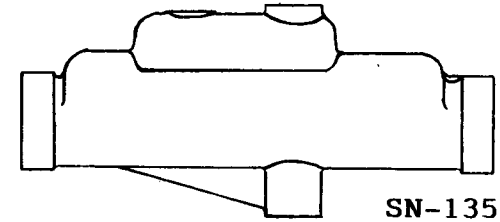
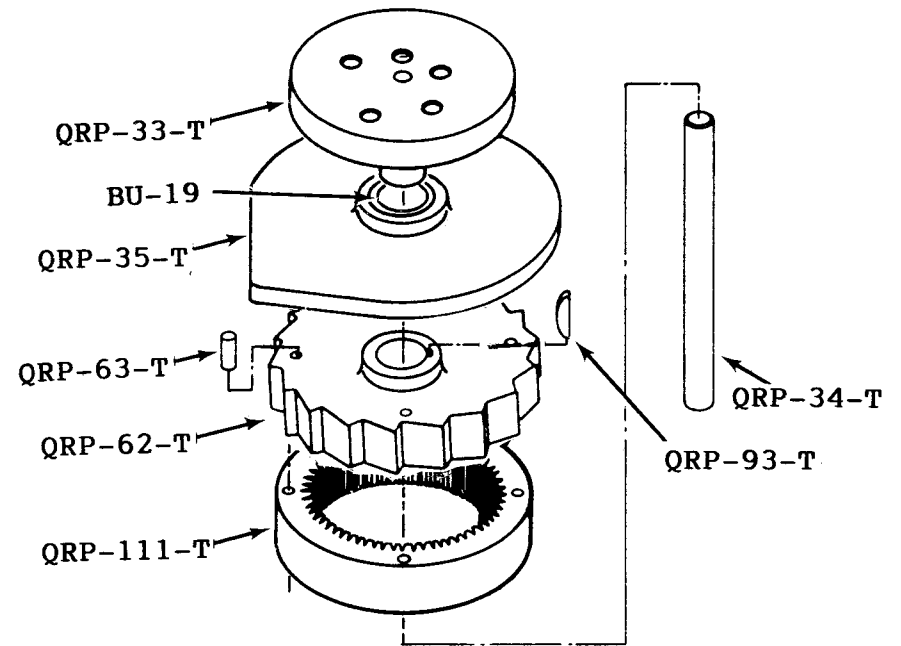

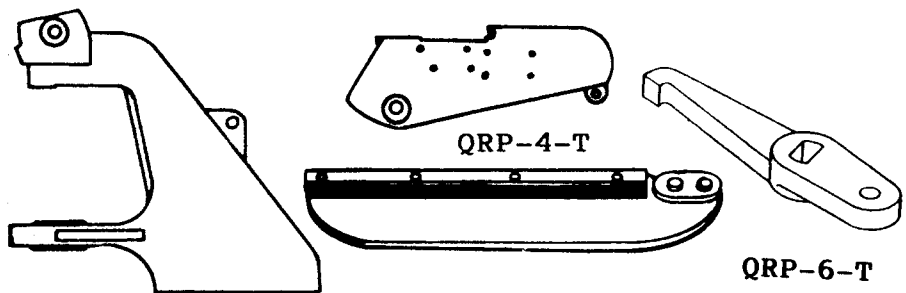

QRP-3-T

QRP-4-T

QRP-6-T

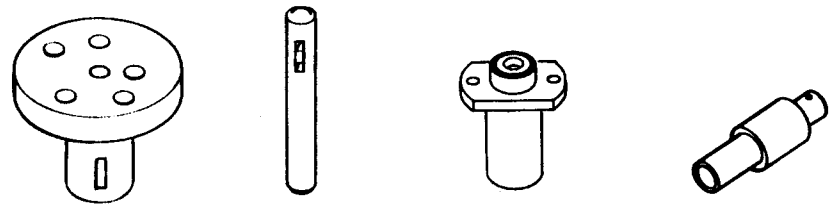

QRP-33-T

QRP-34-T

QRP-36-TS

QRP-38-TS

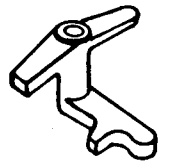

QRP-11-T



QRP-12-T



QRP-13-T

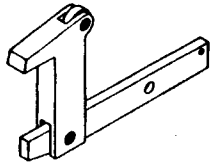

QRP-16-T

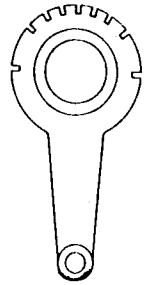

QRP-39-T

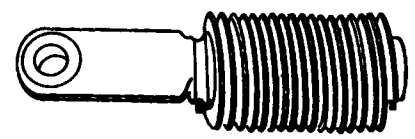

QRP-40-TS

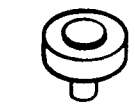

RB-16-BW



BU-16



QRP-21-T

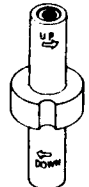

QRP-22-T



QRP-23-S

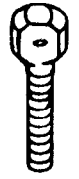

RIGHTHAND
THREAD
QRP-23-T



LEFTHAND
THREAD
QRP-24-T

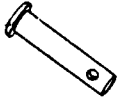

QRP-25-T

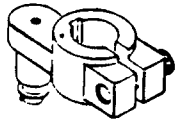

QRP-27-TS



QRP-42-TS



QRP-43-TS

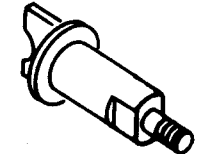

QRP-45-T



QRP-48-S

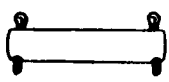

QRP-28-T

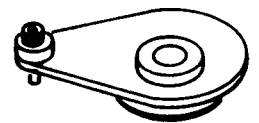

QRP-29-T



QRP-29-Ta

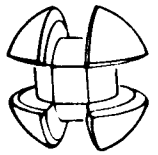

QRP-50-T



QRP-51-S

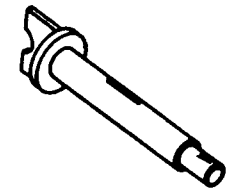

QRP-52-T



QRP-53-TL



BU-30



QRP-31-T

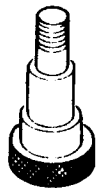

QRP-32-T



QRP-53-TS



QRP-54-S

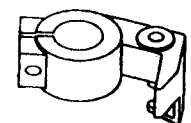

QRP-54-T



QRP-55-T

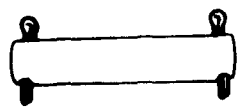

QRP-56-T

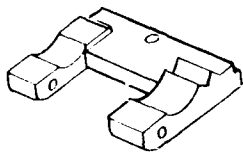

QRP-57-T

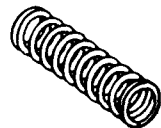

QRP-58-T

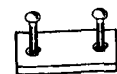

QRP-83-T

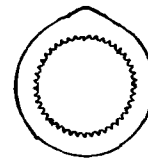

QRP-84-T



QRP-91-T

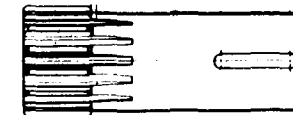

QRP-109-T

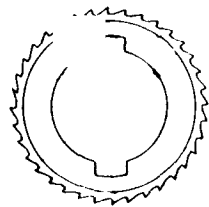

QRP-59-T

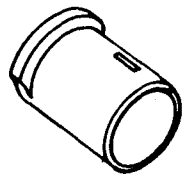

QRP-60-T

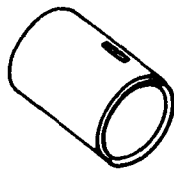

QRP-61-T

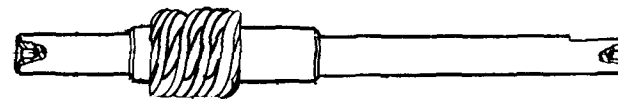

QRP-107-T

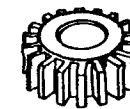

QRP-110-S



QRP-65-TS

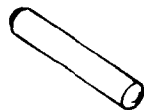

QRP-66-S

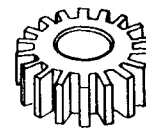

QRP-110-T

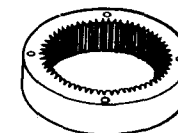

QRP-111-T

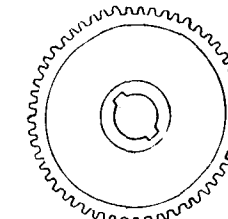

QRP-113-T

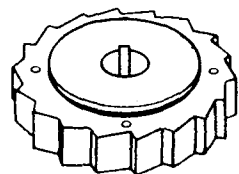

QRP-62-T

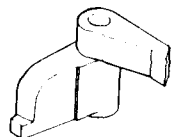

QRP-64-T



QRP-67-T

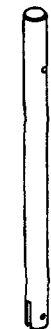

QRP-66-T

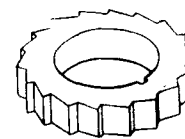

QRP-114-S



QRP-114-T



QRP-116-S

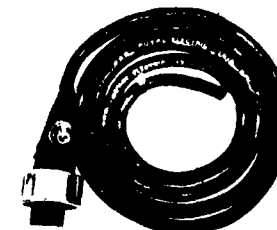

QRP-117-T

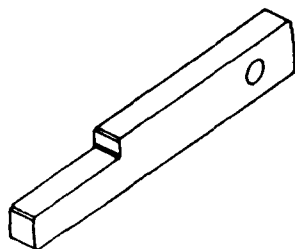

QRP-68-S

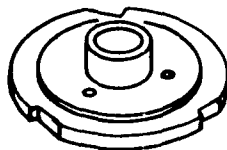

QRP-68-T

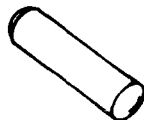

QRP-70-S



QRP-71-S



QRP-118-S



QRP-119-T

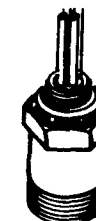

QRP-120-S



QRP-120-Ta



QRP-71-T

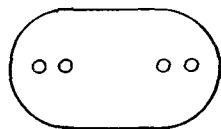

QRP-74-T



QRP-75-T



QRP-76-TS

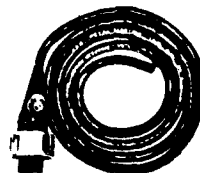

QRP-120-Tb

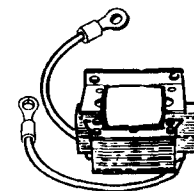

QRP-127-TS

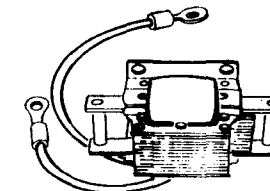

QRP-128-T

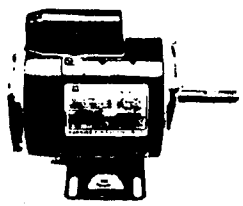

QRP-129-TS



QRP-130-TS



QRP-131-TS

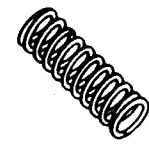

QRP-195-T



QRP-196-S

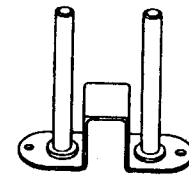

QRP-197-S



QRP-200-S

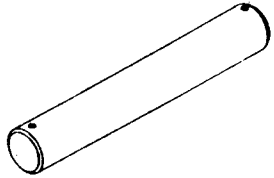

QRP-135-S

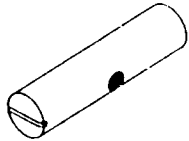

QRP-136-S



QRP-143-AT

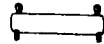

QRP-144-T

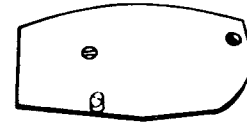

QRP-203-S



QRP-206-S



QRP-214-S

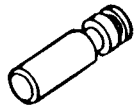

QRP-145-T



QRP-146-AT

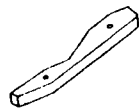

QRP-149-AT

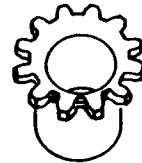

QRP-153-T

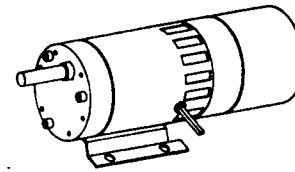

QRP-237-IT

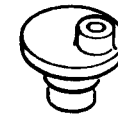

QRP-240-AT



QRP-242-T

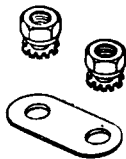

QRP-156-T

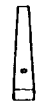

QRP-180-T



QRP-181-T

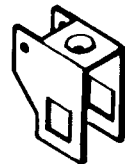

QRP-182-T

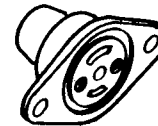

QRP-253-T

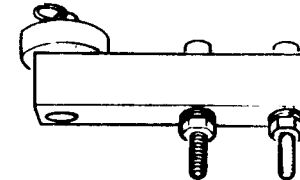

QRP-325-AT

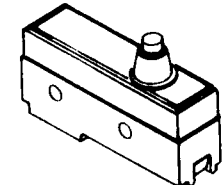

QRP-413-T

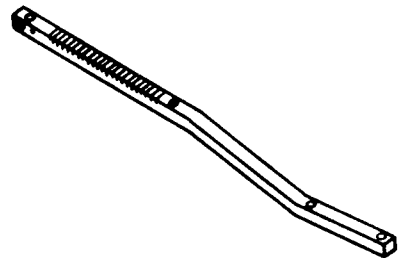

QRP-187-T

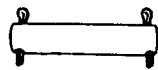

QRP-191-S

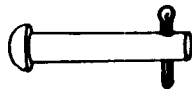

QRP-192-T

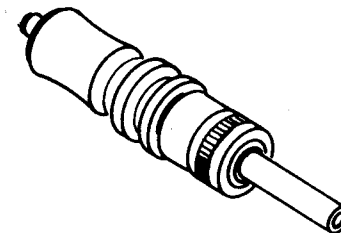

QRP-800-T

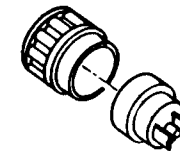

QRP-801-TS

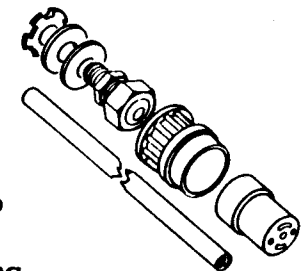

QRP-804-T



QRP-193-T

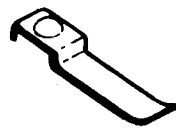

QRP-194-T



QRP-806-T

